

CORNELL PUMP COMPANY

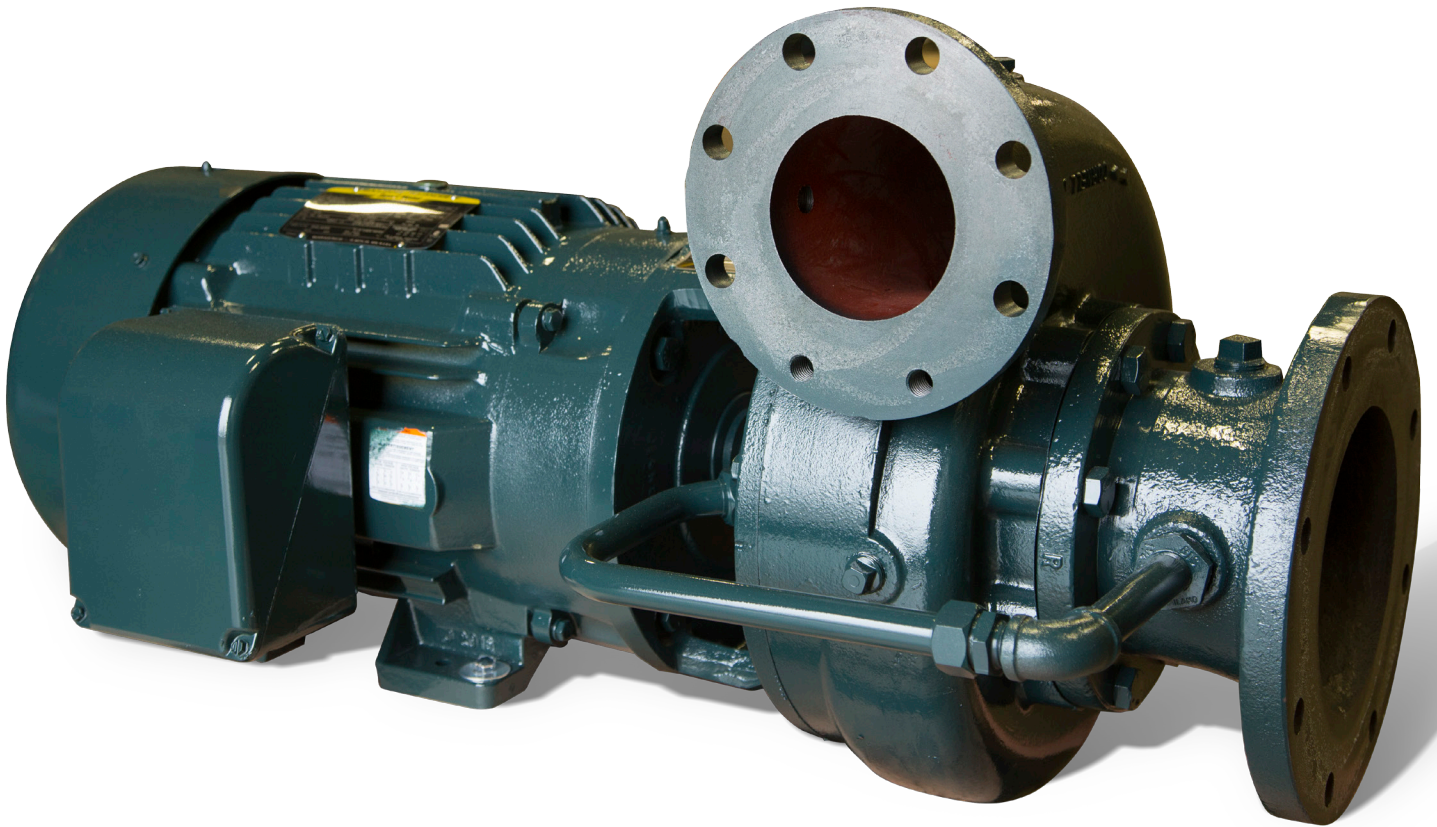

HIGH FLOW/LOW HEAD PUMPS



EFFICIENT BY DESIGN



HIGH FLOW/LOW HEAD PUMPS

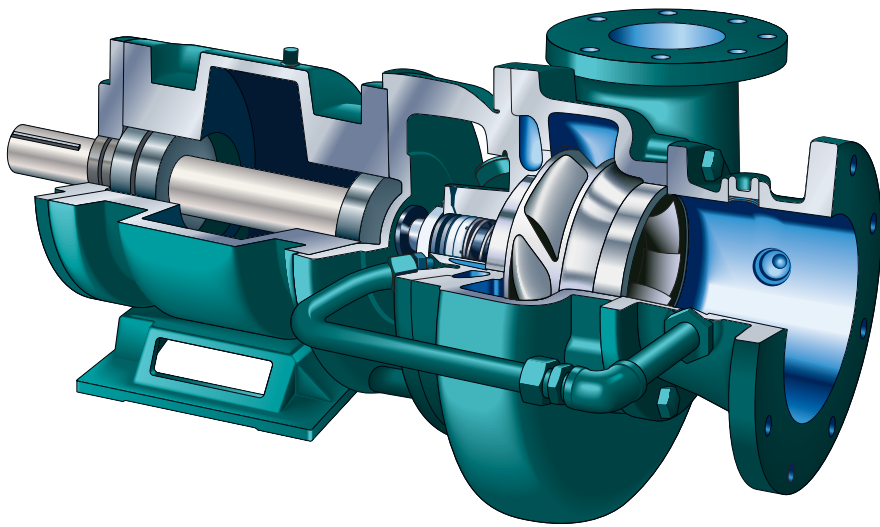

HEAVY-DUTY CENTRIFUGAL PUMPS

Cornell redesigned some of our most popular clear liquids pumps to make the pumps lighter and reduce manufacturing costs. The re-engineered design maintains the same excellent hydraulic efficiencies and performance as previous models.

Our high flow/low head pumps are designed with Cornell's renowned quality and durability. All models are available in horizontal or vertical close-coupled and frame or engine mount configurations. Available in 5", 6" and 10" discharge sizes to handle flows from 520 to 5,100 GM and heads between 11.5' and 129' (5 to 56 PSI).

FEATURES AND BENEFITS

- ✓ Competitively Priced
- ✓ Available in all mounting configurations (CC, Frame and SAE)
- ✓ Packing or Cycloseal® mechanical seal system
- ✓ Back pullout construction for easier maintenance
- ✓ High quality parts and construction
- ✓ 20,000 hour minimum B-10 bearing life
- ✓ High-efficiency hydraulics (>80% BEP)

ALL PUMPS INCLUDE:

- ✓ Standard cast iron construction
- ✓ Bronze shaft sleeve and wear rings
- ✓ Cast iron impeller
- ✓ External Hydraulic Balance Line
- ✓ Replaceable wear rings and shaft sleeve
- ✓ Grease or oil-lubricated bearing frame
- ✓ 2-year warranty

CYCLOSEAL® SYSTEM FOR GRIT REMOVAL

CYCLOSEAL is a self-contained single mechanical seal with a dished backplate. **This configuration requires no external flushing and eliminates the need for a water flush line.** The Cycloseal uses stationary deflector vanes cast into the dished pump backplate in conjunction with contoured impeller back vanes to create pressure gradients that moves solids and entrained vapor away from the seal faces. The Cycloseal system is only available on Cornell pump models.

- No flush water required
- Removes grit from pump seal compartment
- Extends pump seal life three times standard mechanical
- No drips/mess at application site
- Reduced maintenance costs
- Increased uptime and reliability

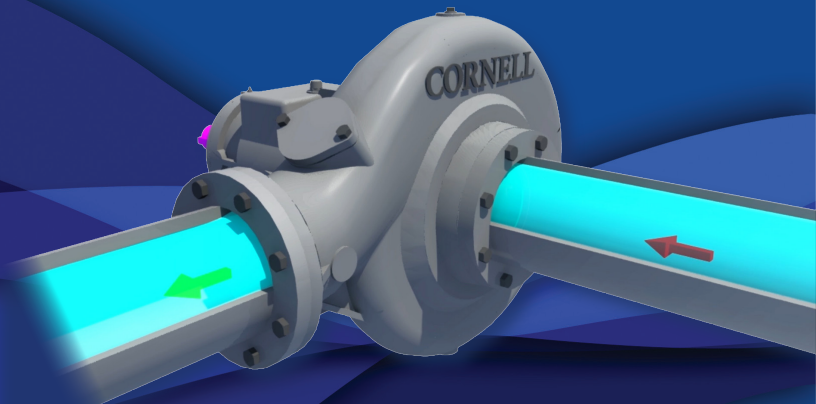

HIGH FLOW/LOW HEAD PUMPS

5WBQ

- Flow rates from 540 to 1,800 GPM
- Pressure from 11.5' to 85' (5 to 37 PSI)
- 84% efficient at Best Efficiency Point
- Dimensions are same as existing 5WBH pump

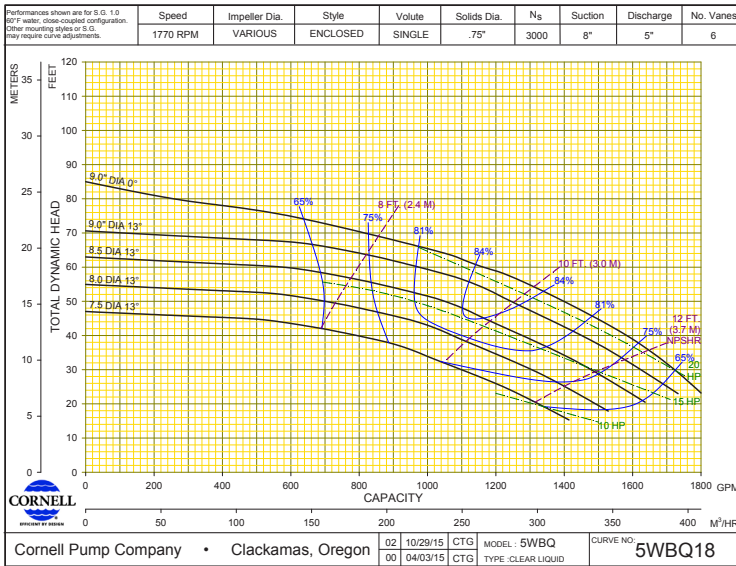

5YBQ

- Flow rates from 520 to 1,850 GPM
- Pressure from 21' to 106' (9 to 46 PSI)
- 85% efficient at Best Efficiency Point
- Dimensions are same as existing 5YBH pump

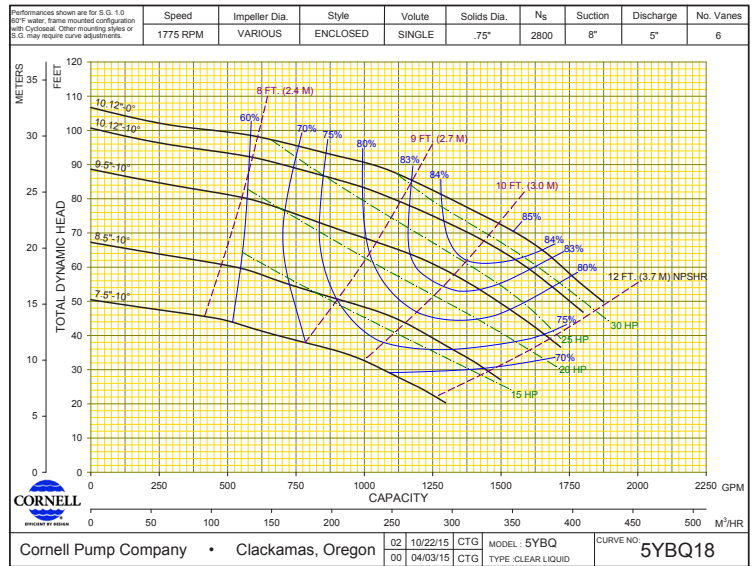

6YBQ

- Flow rates from 1,000 to 2,750 GPM
- Pressure from 21' to 129' (9 to 56 PSI)
- 86% efficient at Best Efficiency Point
- Dimensions are same as existing 6YB pump

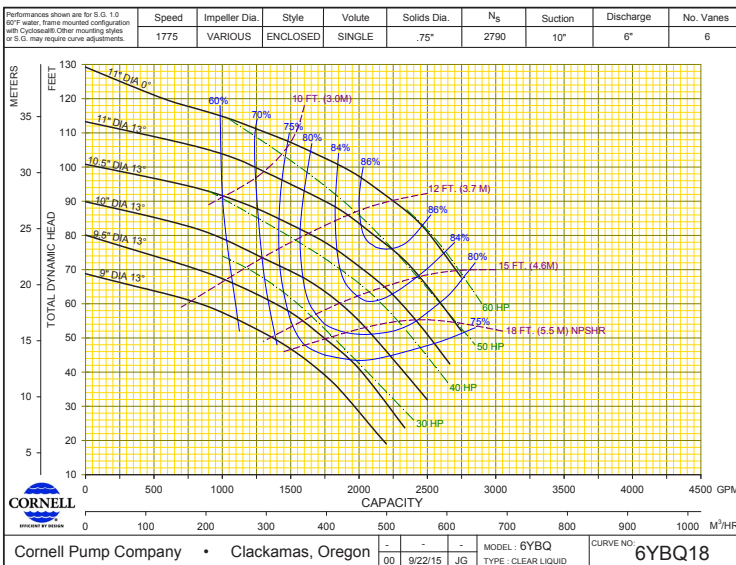

10YBQ

- Flow rates from 1,900 to 5,100 GPM
- Pressure from 28' to 115' (12 to 50 PSI)
- 80% efficient at Best Efficiency Point
- Dimensions are same as existing 10YB pump

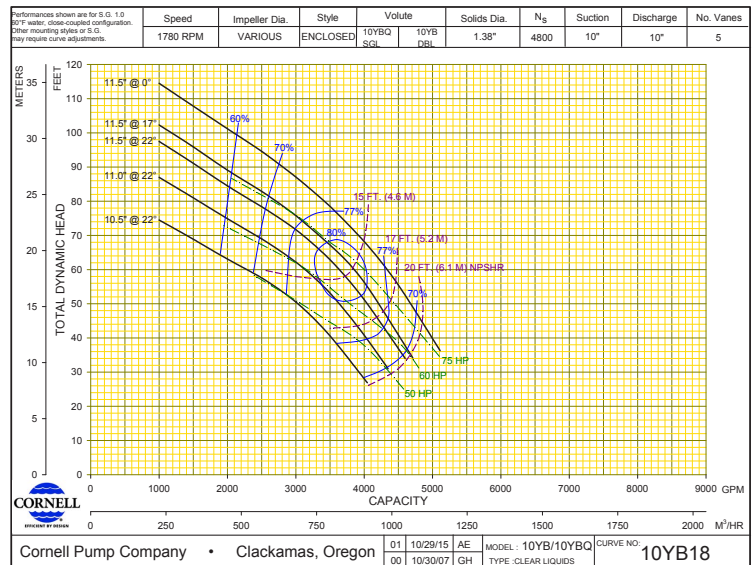



MARKET AND PRODUCT LINE

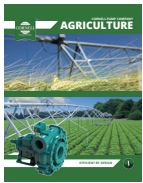

AGRICULTURAL

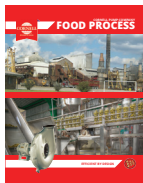

FOOD PROCESS



INDUSTRIAL



MINE DEWATERING



MUNICIPAL



REFRIGERATION



OIL & GAS



CYCLOSEAL®



CHOPPER



CUTTER



EDGE™



HYDRAULIC SUBS



HYDRO TURBINE



IMMERSIBLE



MANURE



MP SERIES



MX SERIES



MX MINING

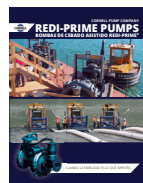

REDI-PRIME®



SELF PRIMING



SLURRY



SUBMERSIBLE



WATER TRANSFER

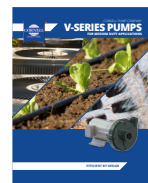

V SERIES

Cycloseal® and Redi-Prime® are Registered Trademarks of Cornell Pump Company.

Cornell pumps and products are the subject of one or more of the following U.S. and foreign patents: 3,207,485; 3,282,226; 3,295,456; 3,301,191; 3,630,637; 3,663,117; 3,743,437; 4,335,886; 4,523,900; 5,489,187; 5,591,001; 6,074,554; 6,036,434; 6,079,958; 6,309,169; 2,320,742; 96/8140; 319,837; 918,534; 1,224,969; 2,232,735; 701,979 and are the subject of pending U.S. and foreign patent applications.

CORNELLPUMP.COM
©2015 CORNELL PUMP COMPANY



Cornell Pump Company
Clackamas, Oregon, USA
P: +1 (503) 653-0330
F: +1 (503) 653-0338

AUTHORIZED CORNELL PUMP DISTRIBUTOR